



SAT[®] Practice Test #3

IMPORTANT REMINDERS

1

**A No. 2 pencil is required for the test.
Do not use a mechanical pencil or pen.**

2

**Sharing any questions with anyone
is a violation of Test Security
and Fairness policies and may result
in your scores being canceled.**

This cover is representative of what you'll see on test day.

**THIS TEST BOOK MUST NOT BE TAKEN FROM THE ROOM. UNAUTHORIZED
REPRODUCTION OR USE OF ANY PART OF THIS TEST BOOK IS PROHIBITED.**



Math Test – No Calculator

25 MINUTES, 20 QUESTIONS

Turn to Section 3 of your answer sheet to answer the questions in this section.

DIRECTIONS

For questions 1-15, solve each problem, choose the best answer from the choices provided, and fill in the corresponding circle on your answer sheet. For questions 16-20, solve the problem and enter your answer in the grid on the answer sheet. Please refer to the directions before question 16 on how to enter your answers in the grid. You may use any available space in your test booklet for scratch work.

NOTES

- The use of a calculator **is not permitted**.
- All variables and expressions used represent real numbers unless otherwise indicated.
- Figures provided in this test are drawn to scale unless otherwise indicated.
- All figures lie in a plane unless otherwise indicated.
- Unless otherwise indicated, the domain of a given function f is the set of all real numbers x for which $f(x)$ is a real number.

REFERENCE

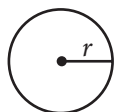

$$A = \pi r^2$$

$$C = 2\pi r$$



$$A = \ell w$$

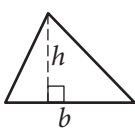

$$A = \frac{1}{2}bh$$

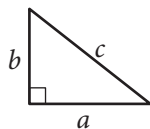

$$c^2 = a^2 + b^2$$

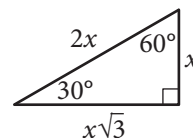

Special Right Triangles

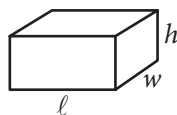
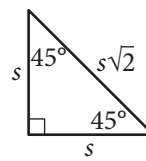

$$V = \ell wh$$

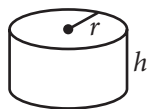

$$V = \pi r^2 h$$



$$V = \frac{4}{3}\pi r^3$$



$$V = \frac{1}{3}\pi r^2 h$$

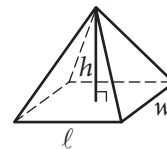

$$V = \frac{1}{3}\ell wh$$

The number of degrees of arc in a circle is 360.

The number of radians of arc in a circle is 2π .

The sum of the measures in degrees of the angles of a triangle is 180.



1

A painter will paint n walls with the same size and shape in a building using a specific brand of paint. The painter's fee can be calculated by the expression $nK\ell h$, where n is the number of walls, K is a constant with units of dollars per square foot, ℓ is the length of each wall in feet, and h is the height of each wall in feet. If the customer asks the painter to use a more expensive brand of paint, which of the factors in the expression would change?

- A) h
- B) ℓ
- C) K
- D) n

2

If $3r = 18$, what is the value of $6r + 3$?

- A) 6
- B) 27
- C) 36
- D) 39

3

Which of the following is equal to $a^{\frac{2}{3}}$, for all values of a ?

- A) $\sqrt{a^3}$
- B) $\sqrt{a^3}$
- C) $\sqrt[3]{a^{\frac{1}{2}}}$
- D) $\sqrt[3]{a^2}$

4

The number of states that joined the United States between 1776 and 1849 is twice the number of states that joined between 1850 and 1900. If 30 states joined the United States between 1776 and 1849 and x states joined between 1850 and 1900, which of the following equations is true?

- A) $30x = 2$
- B) $2x = 30$
- C) $\frac{x}{2} = 30$
- D) $x + 30 = 2$



5

If $\frac{5}{x} = \frac{15}{x+20}$, what is the value of $\frac{x}{5}$?

- A) 10
- B) 5
- C) 2
- D) $\frac{1}{2}$

6

$$2x - 3y = -14$$

$$3x - 2y = -6$$

If (x, y) is a solution to the system of equations above, what is the value of $x - y$?

- A) -20
- B) -8
- C) -4
- D) 8

7

x	$f(x)$
0	3
2	1
4	0
5	-2

The function f is defined by a polynomial. Some values of x and $f(x)$ are shown in the table above. Which of the following must be a factor of $f(x)$?

- A) $x - 2$
- B) $x - 3$
- C) $x - 4$
- D) $x - 5$

8

The line $y = kx + 4$, where k is a constant, is graphed in the xy -plane. If the line contains the point (c, d) , where $c \neq 0$ and $d \neq 0$, what is the slope of the line in terms of c and d ?

- A) $\frac{d-4}{c}$
- B) $\frac{c-4}{d}$
- C) $\frac{4-d}{c}$
- D) $\frac{4-c}{d}$



9

$$kx - 3y = 4$$

$$4x - 5y = 7$$

In the system of equations above, k is a constant and x and y are variables. For what value of k will the system of equations have no solution?

- A) $\frac{12}{5}$
 B) $\frac{16}{7}$
 C) $-\frac{16}{7}$
 D) $-\frac{12}{5}$

10

In the xy -plane, the parabola with equation $y = (x - 11)^2$ intersects the line with equation $y = 25$ at two points, A and B . What is the length of \overline{AB} ?

- A) 10
 B) 12
 C) 14
 D) 16

11

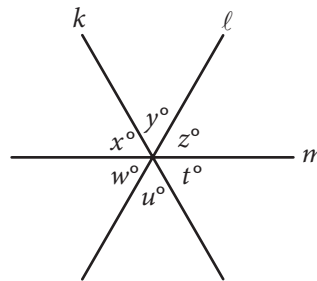

Note: Figure not drawn to scale.

In the figure above, lines k , l , and m intersect at a point. If $x + y = u + w$, which of the following must be true?

- I. $x = z$
 II. $y = w$
 III. $z = t$
- A) I and II only
 B) I and III only
 C) II and III only
 D) I, II, and III

12

$$y = a(x - 2)(x + 4)$$

In the quadratic equation above, a is a nonzero constant. The graph of the equation in the xy -plane is a parabola with vertex (c, d) . Which of the following is equal to d ?

- A) $-9a$
 B) $-8a$
 C) $-5a$
 D) $-2a$



13

The equation $\frac{24x^2 + 25x - 47}{ax - 2} = -8x - 3 - \frac{53}{ax - 2}$ is true for all values of $x \neq \frac{2}{a}$, where a is a constant.

What is the value of a ?

- A) -16
- B) -3
- C) 3
- D) 16

14

What are the solutions to $3x^2 + 12x + 6 = 0$?

- A) $x = -2 \pm \sqrt{2}$
- B) $x = -2 \pm \frac{\sqrt{30}}{3}$
- C) $x = -6 \pm \sqrt{2}$
- D) $x = -6 \pm 6\sqrt{2}$

15

$$C = \frac{5}{9}(F - 32)$$

The equation above shows how a temperature F , measured in degrees Fahrenheit, relates to a temperature C , measured in degrees Celsius. Based on the equation, which of the following must be true?

- I. A temperature increase of 1 degree Fahrenheit is equivalent to a temperature increase of $\frac{5}{9}$ degree Celsius.
- II. A temperature increase of 1 degree Celsius is equivalent to a temperature increase of 1.8 degrees Fahrenheit.
- III. A temperature increase of $\frac{5}{9}$ degree Fahrenheit is equivalent to a temperature increase of 1 degree Celsius.

- A) I only
- B) II only
- C) III only
- D) I and II only

**DIRECTIONS**

For questions 16–20, solve the problem and enter your answer in the grid, as described below, on the answer sheet.

- Although not required, it is suggested that you write your answer in the boxes at the top of the columns to help you fill in the circles accurately. You will receive credit only if the circles are filled in correctly.
- Mark no more than one circle in any column.
- No question has a negative answer.
- Some problems may have more than one correct answer. In such cases, grid only one answer.
- Mixed numbers** such as $3\frac{1}{2}$ must be gridded as 3.5 or 7/2. (If $\begin{array}{|c|c|c|c|} \hline 3 & 1 & / & 2 \\ \hline \bullet & \bullet & \bullet & \bullet \\ \hline \end{array}$ is entered into the grid, it will be interpreted as $\frac{31}{2}$, not $3\frac{1}{2}$.)
- Decimal answers:** If you obtain a decimal answer with more digits than the grid can accommodate, it may be either rounded or truncated, but it must fill the entire grid.

Write answer → in boxes.

Answer: $\frac{7}{12}$

	7	/	1	2	
	•	•	•	•	
	0	0	0	0	
1	1	•	1	1	
2	2	2	•	2	
3	3	3	3	3	
4	4	4	4	4	
5	5	5	5	5	
6	6	6	6	6	
•	7	7	7	7	
8	8	8	8	8	
9	9	9	9	9	

← Fraction line

Grid in result.

Answer: 2.5

	2	.	5	
	•	•	•	•
	0	0	0	
1	1	1	1	
2	•	2	2	
3	3	3	3	
4	4	4	4	
5	5	5	•	
6	6	6	6	
7	7	7	7	
8	8	8	8	
9	9	9	9	

← Decimal point

Acceptable ways to grid $\frac{2}{3}$ are:

	2	/	3	
	•	•	•	•
	0	0	0	
1	1	1	1	
2	•	2	2	
3	3	3	•	
4	4	4	4	
5	5	5	5	
6	6	6	6	
7	7	7	7	
8	8	8	8	
9	9	9	9	

.	6	6	6	
	•	•	•	•
	0	0	0	
1	1	1	1	
2	2	2	2	
3	3	3	3	
4	4	4	4	
5	5	5	5	
6	•	•	•	
7	7	7	7	
8	8	8	8	
9	9	9	9	

.	6	6	7	
	•	•	•	•
	0	0	0	
1	1	1	1	
2	2	2	2	
3	3	3	3	
4	4	4	4	
5	5	5	5	
6	•	•	•	
7	7	7	•	
8	8	8	8	
9	9	9	9	

Answer: 201 – either position is correct

	2	0	1	
	•	•	•	•
	0	•	0	
1	1	1	•	
2	•	2	2	
3	3	3	3	

	2	0	1	
	•	•	•	•
	•	0	0	
1	1	•	1	
2	•	2	2	
3	•	3	3	

NOTE: You may start your answers in any column, space permitting. Columns you don't need to use should be left blank.



16

$$x^3(x^2 - 5) = -4x$$

If $x > 0$, what is one possible solution to the equation above?

17

If $\frac{7}{9}x - \frac{4}{9}x = \frac{1}{4} + \frac{5}{12}$, what is the value of x ?

18

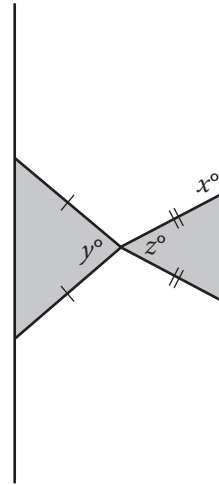

Note: Figure not drawn to scale.

Two isosceles triangles are shown above. If $180 - z = 2y$ and $y = 75$, what is the value of x ?



19

At a lunch stand, each hamburger has 50 more calories than each order of fries. If 2 hamburgers and 3 orders of fries have a total of 1700 calories, how many calories does a hamburger have?

20

In triangle ABC , the measure of $\angle B$ is 90° , $BC = 16$, and $AC = 20$. Triangle DEF is similar to triangle ABC , where vertices D , E , and F correspond to vertices A , B , and C , respectively, and each side of triangle DEF is $\frac{1}{3}$ the length of the corresponding side of triangle ABC . What is the value of $\sin F$?

STOP

If you finish before time is called, you may check your work on this section only.

Do not turn to any other section.



Math Test – Calculator

55 MINUTES, 38 QUESTIONS

Turn to Section 4 of your answer sheet to answer the questions in this section.

DIRECTIONS

For questions 1-30, solve each problem, choose the best answer from the choices provided, and fill in the corresponding circle on your answer sheet. For questions 31-38, solve the problem and enter your answer in the grid on the answer sheet. Please refer to the directions before question 31 on how to enter your answers in the grid. You may use any available space in your test booklet for scratch work.

NOTES

- The use of a calculator **is permitted**.
- All variables and expressions used represent real numbers unless otherwise indicated.
- Figures provided in this test are drawn to scale unless otherwise indicated.
- All figures lie in a plane unless otherwise indicated.
- Unless otherwise indicated, the domain of a given function f is the set of all real numbers x for which $f(x)$ is a real number.

REFERENCE

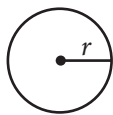

$$A = \pi r^2$$

$$C = 2\pi r$$

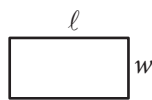

$$A = \ell w$$

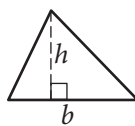

$$A = \frac{1}{2}bh$$

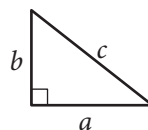

$$c^2 = a^2 + b^2$$

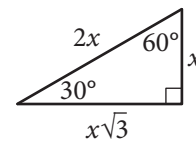

Special Right Triangles

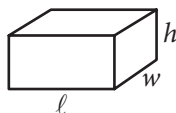
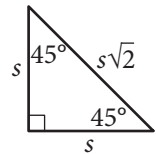

$$V = \ell wh$$

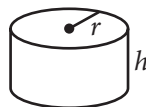

$$V = \pi r^2 h$$

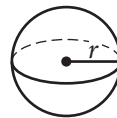

$$V = \frac{4}{3}\pi r^3$$

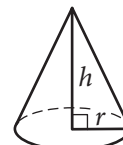

$$V = \frac{1}{3}\pi r^2 h$$

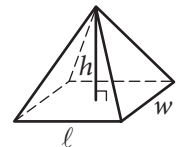

$$V = \frac{1}{3}\ell wh$$

The number of degrees of arc in a circle is 360.

The number of radians of arc in a circle is 2π .

The sum of the measures in degrees of the angles of a triangle is 180.



1

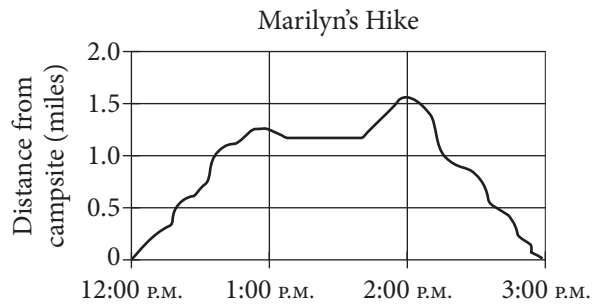

The graph above shows Marilyn's distance from her campsite during a 3-hour hike. She stopped for 30 minutes during her hike to have lunch. Based on the graph, which of the following is closest to the time she finished lunch and continued her hike?

- A) 12:40 P.M.
- B) 1:10 P.M.
- C) 1:40 P.M.
- D) 2:00 P.M.

2

Gender	Age		Total
	Under 40	40 or older	
Male	12	2	14
Female	8	3	11
Total	20	5	25

The table above shows the distribution of age and gender for 25 people who entered a contest. If the contest winner will be selected at random, what is the probability that the winner will be either a female under age 40 or a male age 40 or older?

- A) $\frac{4}{25}$
- B) $\frac{10}{25}$
- C) $\frac{11}{25}$
- D) $\frac{16}{25}$



3

The graph below shows the total number of music album sales, in millions, each year from 1997 through 2009.

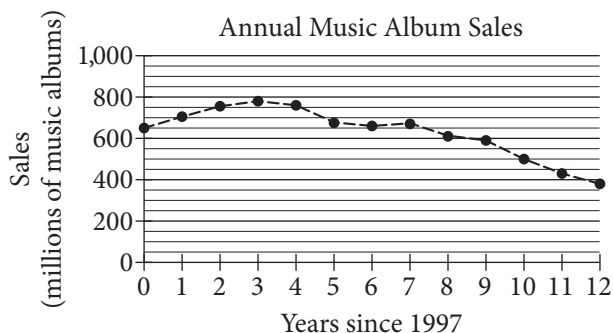

Based on the graph, which of the following best describes the general trend in music album sales from 1997 through 2009?

- A) Sales generally increased each year since 1997.
- B) Sales generally decreased each year since 1997.
- C) Sales increased until 2000 and then generally decreased.
- D) Sales generally remained steady from 1997 through 2009.

4

n	1	2	3	4
$f(n)$	-2	1	4	7

The table above shows some values of the linear function f . Which of the following defines f ?

- A) $f(n) = n - 3$
- B) $f(n) = 2n - 4$
- C) $f(n) = 3n - 5$
- D) $f(n) = 4n - 6$

5

At Lincoln High School, approximately 7 percent of enrolled juniors and 5 percent of enrolled seniors were inducted into the National Honor Society last year. If there were 562 juniors and 602 seniors enrolled at Lincoln High School last year, which of the following is closest to the total number of juniors and seniors at Lincoln High School last year who were inducted into the National Honor Society?

- A) 140
- B) 69
- C) 39
- D) 30

6

$$3x^2 - 5x + 2$$

$$5x^2 - 2x - 6$$

Which of the following is the sum of the two polynomials shown above?

- A) $8x^2 - 7x - 4$
- B) $8x^2 + 7x - 4$
- C) $8x^4 - 7x^2 - 4$
- D) $8x^4 + 7x^2 - 4$



7

If $\frac{3}{5}w = \frac{4}{3}$, what is the value of w ?

- A) $\frac{9}{20}$
- B) $\frac{4}{5}$
- C) $\frac{5}{4}$
- D) $\frac{20}{9}$

8

The average number of students per classroom at Central High School from 2000 to 2010 can be modeled by the equation $y = 0.56x + 27.2$, where x represents the number of years since 2000, and y represents the average number of students per classroom. Which of the following best describes the meaning of the number 0.56 in the equation?

- A) The total number of students at the school in 2000
- B) The average number of students per classroom in 2000
- C) The estimated increase in the average number of students per classroom each year
- D) The estimated difference between the average number of students per classroom in 2010 and in 2000

9

Nate walks 25 meters in 13.7 seconds. If he walks at this same rate, which of the following is closest to the distance he will walk in 4 minutes?

- A) 150 meters
- B) 450 meters
- C) 700 meters
- D) 1,400 meters



Questions 10 and 11 refer to the following information.

Planet	Acceleration due to gravity $\left(\frac{\text{m}}{\text{sec}^2}\right)$
Mercury	3.6
Venus	8.9
Earth	9.8
Mars	3.8
Jupiter	26.0
Saturn	11.1
Uranus	10.7
Neptune	14.1

The chart above shows approximations of the acceleration due to gravity in meters per second squared $\left(\frac{\text{m}}{\text{sec}^2}\right)$ for the eight planets in our solar system. The weight of an object on a given planet can be found by using the formula $W = mg$, where W is the weight of the object measured in newtons, m is the mass of the object measured in kilograms, and g is the acceleration due to gravity on the planet measured in $\frac{\text{m}}{\text{sec}^2}$.

10

What is the weight, in newtons, of an object on Mercury with a mass of 90 kilograms?

- A) 25
- B) 86
- C) 101
- D) 324

11

An object on Earth has a weight of 150 newtons. On which planet would the same object have an approximate weight of 170 newtons?

- A) Venus
- B) Saturn
- C) Uranus
- D) Neptune



12

If the function f has five distinct zeros, which of the following could represent the complete graph of f in the xy -plane?

A)

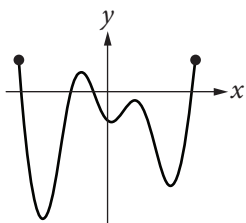

B)

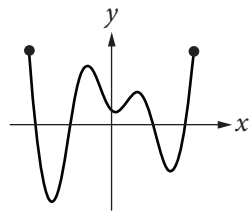

C)

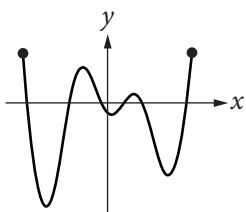

D)

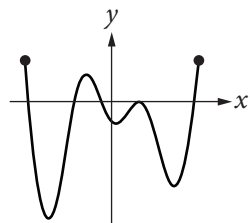

13

$$h = -16t^2 + vt + k$$

The equation above gives the height h , in feet, of a ball t seconds after it is thrown straight up with an initial speed of v feet per second from a height of k feet. Which of the following gives v in terms of h , t , and k ?

A) $v = h + k - 16t$

B) $v = \frac{h - k + 16}{t}$

C) $v = \frac{h + k}{t} - 16t$

D) $v = \frac{h - k}{t} + 16t$

14

The cost of using a telephone in a hotel meeting room is \$0.20 per minute. Which of the following equations represents the total cost c , in dollars, for h hours of phone use?

A) $c = 0.20(60h)$

B) $c = 0.20h + 60$

C) $c = \frac{60h}{0.20}$

D) $c = \frac{0.20h}{60}$



15

In order to determine if treatment X is successful in improving eyesight, a research study was conducted. From a large population of people with poor eyesight, 300 participants were selected at random. Half of the participants were randomly assigned to receive treatment X, and the other half did not receive treatment X. The resulting data showed that participants who received treatment X had significantly improved eyesight as compared to those who did not receive treatment X. Based on the design and results of the study, which of the following is an appropriate conclusion?

- A) Treatment X is likely to improve the eyesight of people who have poor eyesight.
- B) Treatment X improves eyesight better than all other available treatments.
- C) Treatment X will improve the eyesight of anyone who takes it.
- D) Treatment X will cause a substantial improvement in eyesight.

16

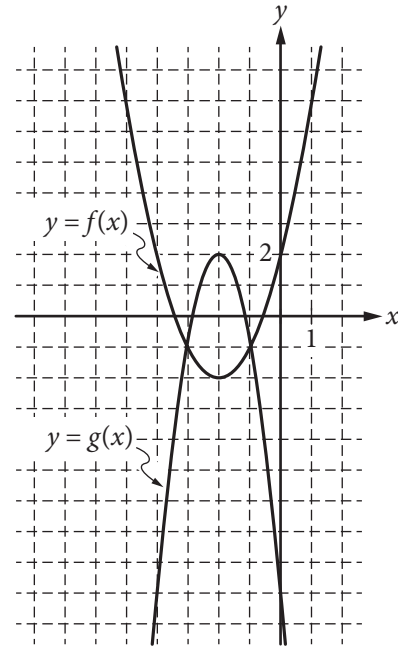

Graphs of the functions f and g are shown in the xy -plane above. For which of the following values of x does $f(x) + g(x) = 0$?

- A) -3
- B) -2
- C) -1
- D) 0



Questions 17 and 18 refer to the following information.

$$S(P) = \frac{1}{2}P + 40$$
$$D(P) = 220 - P$$

The quantity of a product supplied and the quantity of the product demanded in an economic market are functions of the price of the product. The functions above are the estimated supply and demand functions for a certain product. The function $S(P)$ gives the quantity of the product supplied to the market when the price is P dollars, and the function $D(P)$ gives the quantity of the product demanded by the market when the price is P dollars.

17

How will the quantity of the product supplied to the market change if the price of the product is increased by \$10?

- A) The quantity supplied will decrease by 5 units.
- B) The quantity supplied will increase by 5 units.
- C) The quantity supplied will increase by 10 units.
- D) The quantity supplied will increase by 50 units.

18

At what price will the quantity of the product supplied to the market equal the quantity of the product demanded by the market?

- A) \$90
- B) \$120
- C) \$133
- D) \$155

19

Graphene, which is used in the manufacture of integrated circuits, is so thin that a sheet weighing one ounce can cover up to 7 football fields. If a football field has an area of approximately $1\frac{1}{3}$ acres, about how many acres could 48 ounces of graphene cover?

- A) 250
- B) 350
- C) 450
- D) 1,350



20

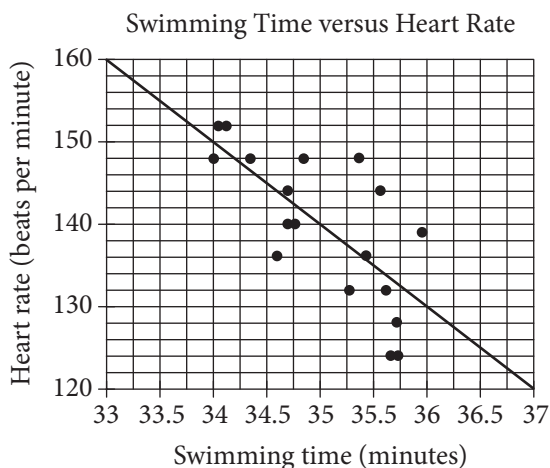

Michael swam 2,000 yards on each of eighteen days. The scatterplot above shows his swim time for and corresponding heart rate after each swim. The line of best fit for the data is also shown. For the swim that took 34 minutes, Michael's actual heart rate was about how many beats per minutes less than the rate predicted by the line of best fit?

- A) 1
- B) 2
- C) 3
- D) 4

21

Of the following four types of savings account plans, which option would yield exponential growth of the money in the account?

- A) Each successive year, 2% of the initial savings is added to the value of the account.
- B) Each successive year, 1.5% of the initial savings and \$100 is added to the value of the account.
- C) Each successive year, 1% of the current value is added to the value of the account.
- D) Each successive year, \$100 is added to the value of the account.

22

The sum of three numbers is 855. One of the numbers, x , is 50% more than the sum of the other two numbers. What is the value of x ?

- A) 570
- B) 513
- C) 214
- D) 155



23

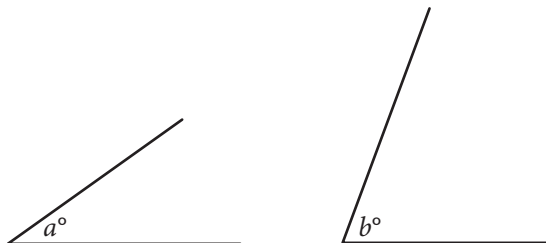

Note: Figures not drawn to scale.

The angles shown above are acute and $\sin(a^\circ) = \cos(b^\circ)$. If $a = 4k - 22$ and $b = 6k - 13$, what is the value of k ?

- A) 4.5
- B) 5.5
- C) 12.5
- D) 21.5

24

Mr. Kohl has a beaker containing n milliliters of solution to distribute to the students in his chemistry class. If he gives each student 3 milliliters of solution, he will have 5 milliliters left over. In order to give each student 4 milliliters of solution, he will need an additional 21 milliliters. How many students are in the class?

- A) 16
- B) 21
- C) 23
- D) 26

25

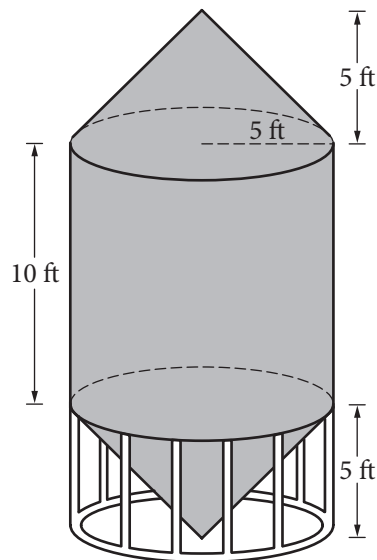

A grain silo is built from two right circular cones and a right circular cylinder with internal measurements represented by the figure above. Of the following, which is closest to the volume of the grain silo, in cubic feet?

- A) 261.8
- B) 785.4
- C) 916.3
- D) 1,047.2



26

In the xy -plane, the line determined by the points $(2, k)$ and $(k, 32)$ passes through the origin. Which of the following could be the value of k ?

- A) 0
- B) 4
- C) 8
- D) 16

27

A rectangle was altered by increasing its length by 10 percent and decreasing its width by p percent. If these alterations decreased the area of the rectangle by 12 percent, what is the value of p ?

- A) 12
- B) 15
- C) 20
- D) 22

28

In planning maintenance for a city's infrastructure, a civil engineer estimates that, starting from the present, the population of the city will decrease by 10 percent every 20 years. If the present population of the city is 50,000, which of the following expressions represents the engineer's estimate of the population of the city t years from now?

- A) $50,000(0.1)^{20t}$
- B) $50,000(0.1)^{\frac{t}{20}}$
- C) $50,000(0.9)^{20t}$
- D) $50,000(0.9)^{\frac{t}{20}}$



29

Gender	Handedness	
	Left	Right
Female		
Male		
Total	18	122

The incomplete table above summarizes the number of left-handed students and right-handed students by gender for the eighth-grade students at Keisel Middle School. There are 5 times as many right-handed female students as there are left-handed female students, and there are 9 times as many right-handed male students as there are left-handed male students. If there is a total of 18 left-handed students and 122 right-handed students in the school, which of the following is closest to the probability that a right-handed student selected at random is female? (Note: Assume that none of the eighth-grade students are both right-handed and left-handed.)

- A) 0.410
- B) 0.357
- C) 0.333
- D) 0.250

30

$$3x + b = 5x - 7$$

$$3y + c = 5y - 7$$

In the equations above, b and c are constants.

If b is c minus $\frac{1}{2}$, which of the following is true?

- A) x is y minus $\frac{1}{4}$.
- B) x is y minus $\frac{1}{2}$.
- C) x is y minus 1.
- D) x is y plus $\frac{1}{2}$.

DIRECTIONS

For questions 31-38, solve the problem and enter your answer in the grid, as described below, on the answer sheet.

- Although not required, it is suggested that you write your answer in the boxes at the top of the columns to help you fill in the circles accurately. You will receive credit only if the circles are filled in correctly.
- Mark no more than one circle in any column.
- No question has a negative answer.
- Some problems may have more than one correct answer. In such cases, grid only one answer.
- Mixed numbers** such as $3\frac{1}{2}$ must be gridded as 3.5 or 7/2. (If

3	1	/	2
•	•	•	•

 is entered into the grid, it will be interpreted as $\frac{31}{2}$, not $3\frac{1}{2}$.)
- Decimal answers:** If you obtain a decimal answer with more digits than the grid can accommodate, it may be either rounded or truncated, but it must fill the entire grid.

Write answer in boxes. →

← Fraction line

← Decimal point

Grid in result.

Answer: $\frac{7}{12}$			
7	/	1	2
•	•	•	•
0	0	0	0
①	①	①	①
②	②	②	②
③	③	③	③
④	④	④	④
⑤	⑤	⑤	⑤
⑥	⑥	⑥	⑥
⑦	⑦	⑦	⑦
⑧	⑧	⑧	⑧
⑨	⑨	⑨	⑨

Answer: 2.5			
2	.	5	
•	•	•	•
0	0	0	0
①	①	①	①
②	②	②	②
③	③	③	③
④	④	④	④
⑤	⑤	⑤	⑤
⑥	⑥	⑥	⑥
⑦	⑦	⑦	⑦
⑧	⑧	⑧	⑧
⑨	⑨	⑨	⑨

Acceptable ways to grid $\frac{2}{3}$ are:

2	/	3	
•	•	•	•
0	0	0	0
①	①	①	①
②	②	②	②
③	③	③	③
④	④	④	④
⑤	⑤	⑤	⑤
⑥	⑥	⑥	⑥
⑦	⑦	⑦	⑦
⑧	⑧	⑧	⑧
⑨	⑨	⑨	⑨

.	6	6	6
•	•	•	•
0	0	0	0
①	①	①	①
②	②	②	②
③	③	③	③
④	④	④	④
⑤	⑤	⑤	⑤
⑥	⑥	⑥	⑥
⑦	⑦	⑦	⑦
⑧	⑧	⑧	⑧
⑨	⑨	⑨	⑨

.	6	6	7
•	•	•	•
0	0	0	0
①	①	①	①
②	②	②	②
③	③	③	③
④	④	④	④
⑤	⑤	⑤	⑤
⑥	⑥	⑥	⑥
⑦	⑦	⑦	⑦
⑧	⑧	⑧	⑧
⑨	⑨	⑨	⑨

Answer: 201 – either position is correct

2	0	1	
•	•	•	•
0	0	0	0
①	①	①	①
②	②	②	②
③	③	③	③

2	0	1	
•	•	•	•
0	0	0	0
①	①	①	①
②	②	②	②
③	③	③	③

NOTE: You may start your answers in any column, space permitting. Columns you don't need to use should be left blank.



31

Tickets for a school talent show cost \$2 for students and \$3 for adults. If Chris spends at least \$11 but no more than \$14 on x student tickets and 1 adult ticket, what is one possible value of x ?

32

Ages of the First 12 United States Presidents at the Beginning of Their Terms in Office

President	Age (years)	President	Age (years)
Washington	57	Jackson	62
Adams	62	Van Buren	55
Jefferson	58	Harrison	68
Madison	58	Tyler	51
Monroe	59	Polk	50
Adams	58	Taylor	65

The table above lists the ages of the first 12 United States presidents when they began their terms in office. According to the table, what was the mean age, in years, of these presidents at the beginning of their terms? (Round your answer to the nearest tenth.)

33

$$(-3x^2 + 5x - 2) - 2(x^2 - 2x - 1)$$

If the expression above is rewritten in the form $ax^2 + bx + c$, where a , b , and c are constants, what is the value of b ?

34

In a circle with center O , central angle AOB has a measure of $\frac{5\pi}{4}$ radians. The area of the sector formed by central angle AOB is what fraction of the area of the circle?



35

An online store receives customer satisfaction ratings between 0 and 100, inclusive. In the first 10 ratings the store received, the average (arithmetic mean) of the ratings was 75. What is the least value the store can receive for the 11th rating and still be able to have an average of at least 85 for the first 20 ratings?

36

$$y \leq -15x + 3000$$

$$y \leq 5x$$

In the xy -plane, if a point with coordinates (a, b) lies in the solution set of the system of inequalities above, what is the maximum possible value of b ?



Questions 37 and 38 refer to the following information.

If shoppers enter a store at an average rate of r shoppers per minute and each stays in the store for an average time of T minutes, the average number of shoppers in the store, N , at any one time is given by the formula $N = rT$. This relationship is known as Little's law.

The owner of the Good Deals Store estimates that during business hours, an average of 3 shoppers per minute enter the store and that each of them stays an average of 15 minutes. The store owner uses Little's law to estimate that there are 45 shoppers in the store at any time.

37

Little's law can be applied to any part of the store, such as a particular department or the checkout lines. The store owner determines that, during business hours, approximately 84 shoppers per hour make a purchase and each of these shoppers spend an average of 5 minutes in the checkout line. At any time during business hours, about how many shoppers, on average, are waiting in the checkout line to make a purchase at the Good Deals Store?

38

The owner of the Good Deals Store opens a new store across town. For the new store, the owner estimates that, during business hours, an average of 90 shoppers per hour enter the store and each of them stays an average of 12 minutes. The average number of shoppers in the new store at any time is what percent less than the average number of shoppers in the original store at any time? (Note: Ignore the percent symbol when entering your answer. For example, if the answer is 42.1%, enter 42.1)

STOP

If you finish before time is called, you may check your work on this section only.

Do not turn to any other section.

No Test Material On This Page

No Test Material On This Page

No Test Material On This Page

No Test Material On This Page

No Test Material On This Page

No Test Material On This Page

YOUR NAME (PRINT) LAST FIRST MI

TEST CENTER NUMBER NAME OF TEST CENTER ROOM NUMBER

The SAT

GENERAL DIRECTIONS

- You may work on only one section at a time.
- If you finish a section before time is called, check your work on that section. You may NOT turn to any other section.

MARKING ANSWERS

- Be sure to mark your answer sheet properly.

COMPLETE MARK  EXAMPLES OF INCOMPLETE MARKS    
   

- You must use a No. 2 pencil.
- Carefully mark only one answer for each question.
- Make sure you fill the entire circle darkly and completely.
- Do not make any stray marks on your answer sheet.
- If you erase, do so completely. Incomplete erasures may be scored as intended answers.
- Use only the answer spaces that correspond to the question numbers.

USING YOUR TEST BOOK

- You may use the test book for scratch work, but you will not receive credit for anything that you write in your test book.
- After time has been called, you may not transfer answers from your test book to your answer sheet or fill in circles.
- You may not fold or remove pages or portions of a page from this book, or take the book or answer sheet from the testing room.

SCORING

- For each correct answer, you receive one point.
- You do not lose points for wrong answers; therefore, you should try to answer every question even if you are not sure of the correct answer.

IMPORTANT

The codes below are unique to your test book. Copy them on your answer sheet in boxes 8 and 9 and fill in the corresponding circles exactly as shown.

9	TEST ID					
	(Copy from back of test book.)					

8	FORM CODE					
	(Copy and grid as on back of test book.)					
(A)	(A)	(A)	(A)	(0)	(0)	(0)
(B)	(B)	(B)	(B)	(1)	(1)	(1)
(C)	(C)	(C)	(C)	(2)	(2)	(2)
(D)	(D)	(D)	(D)	(3)	(3)	(3)
(E)	(E)	(E)	(E)	(4)	(4)	(4)
(F)	(F)	(F)	(F)	(5)	(5)	(5)
(G)	(G)	(G)	(G)	(6)	(6)	(6)
(H)	(H)	(H)	(H)	(7)	(7)	(7)
(I)	(I)	(I)	(I)	(8)	(8)	(8)
(J)	(J)	(J)	(J)	(9)	(9)	(9)
(K)	(K)	(K)	(K)			
(L)	(L)	(L)	(L)			
(M)	(M)	(M)	(M)			
(N)	(N)	(N)	(N)			
(O)	(O)	(O)	(O)			
(P)	(P)	(P)	(P)			
(Q)	(Q)	(Q)	(Q)			
(R)	(R)	(R)	(R)			
(S)	(S)	(S)	(S)			
(T)	(T)	(T)	(T)			
(U)	(U)	(U)	(U)			
(V)	(V)	(V)	(V)			
(W)	(W)	(W)	(W)			
(X)	(X)	(X)	(X)			
(Y)	(Y)	(Y)	(Y)			
(Z)	(Z)	(Z)	(Z)			

Follow this link for more information on scoring your practice test:
www.sat.org/scoring

DO NOT OPEN THIS BOOK UNTIL THE SUPERVISOR TELLS YOU TO DO SO.